

版本 REV.	日期 DATE	ECN NO.	变更内容 DESCRIPTION	制图 DRAWN

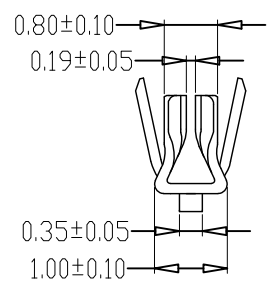
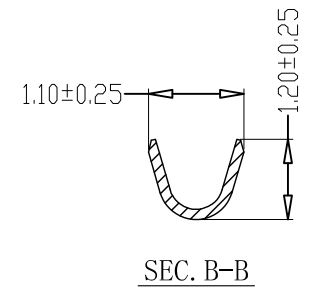
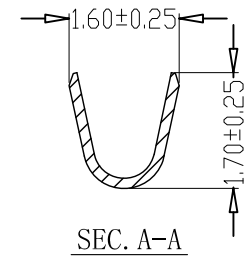
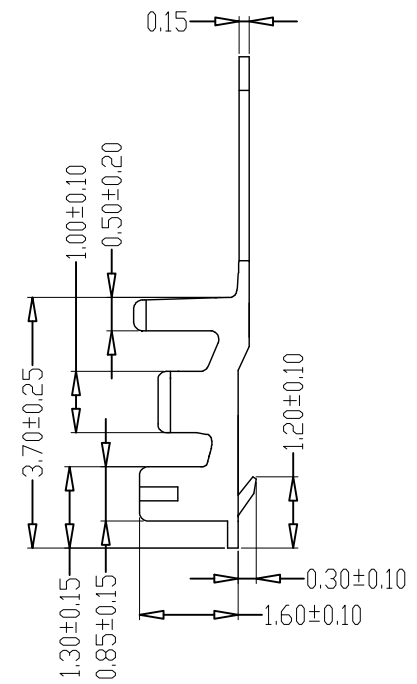
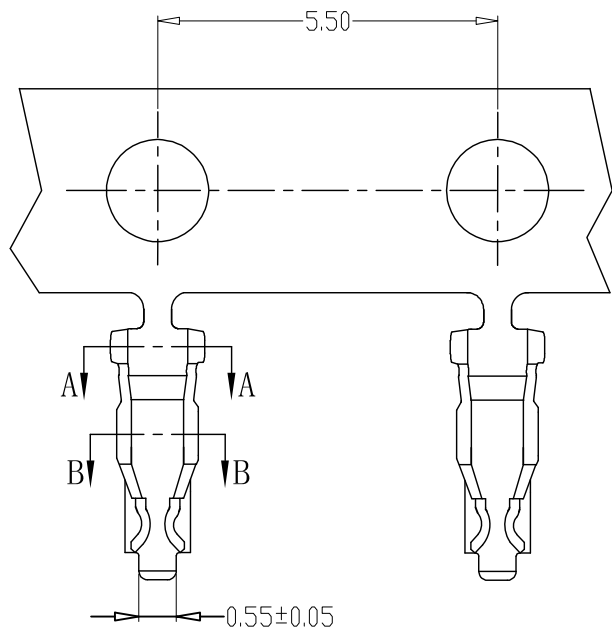

- SPECIFICATIONS
- 1、Current Rating: 1A AC, DC
 - 2、Voltage Rating: 150V AC, DC
 - 3、Temperatuer Range: -25℃~+85℃
 - 4、Contact Resistance: 20mΩ Max
 - 5、Insulation Resistance: 500mΩ Min
 - 6、Withstanding Voltang: 500V AC/minute
 - 7、Material:Phosphoric bronze Tin-plated
 - 8、Applicable Wire Sizes:AWG#28~32#

GENERAL TOLERANCE		制图	张迎春	料号	A12506-T	版本	A
X.X±0.25	X.*±2'	DRAWING	2022、08、29	PART NO.		REV.	
X.XXX±0.10		审核	钱岳生	品名	DF13端子	页次	1/1
X.XX±0.20		CHECK	2022、08、29	客户料号			
		核准	张名	CUTM. NO.			
		APPROVAL	2022、08、30	 乐清市宏一电子有限公司 YueQing HongYi Electronics Co., Ltd			
		单位	MM				

版本 REV.	日期 DATE	ECN NO.	变更内容 DESCRIPTION	制图 DRAWN

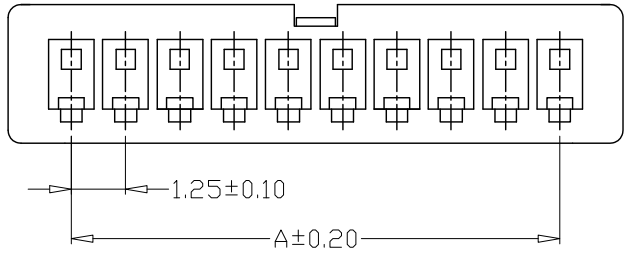

SPECIFICATIONS

- Current Rating: 1A AC, DC
- Voltage Rating: 150V AC, DC
- Temperatuer Range: -25°C~+85°C
- Contact Resistance: 20mΩ Max
- Insulation Resistance: 500MΩ Min
- Withstanding Voltang: 500V AC/minute
- Material: PA66, UL94V-0

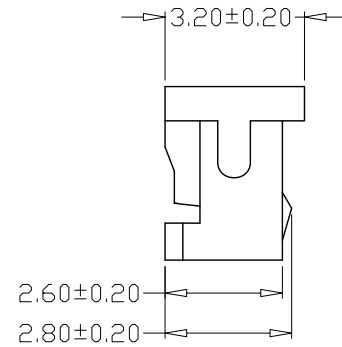
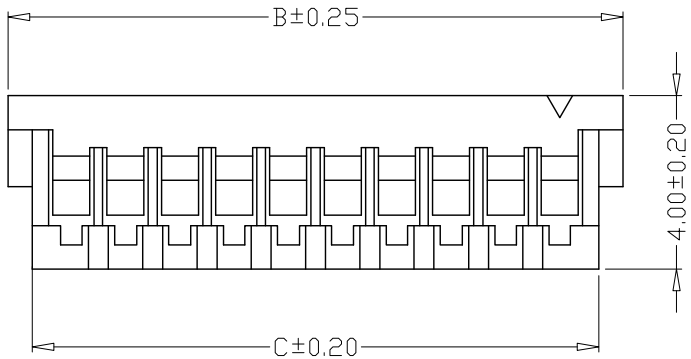

PIN	尺寸 (mm)		
	A	B	C
-02Y	1.25	4.15	3.05
-03Y	2.50	5.40	4.30
-04Y	3.75	6.65	5.55
-05Y	5.00	7.90	6.80
-06Y	6.25	9.15	8.05
-07Y	7.50	10.40	9.30
-08Y	8.75	11.65	10.55
-09Y	10.00	12.90	11.80
-10Y	11.25	14.15	13.05
-11Y	12.50	15.40	14.30
-12Y	13.75	16.65	15.55
-13Y	15.00	17.90	17.90
-14Y	16.25	19.15	18.05
-15Y	17.50	20.40	19.30

GENERAL TOLERANCE		制图 DRAWING	张迎春 2022、08、29	料号 PART NO.	A12506-nY	版本 REV.	A
X.X±0.25	X.*±2'	审核 CHECK	钱岳生 2022、08、29	品名 TITLE	DF13(单排)孔座	页次 SHEET	1/1
X.XXX±0.10		核准 APPROVAL	张名 2022、08、30	客户料号 CUTM. NO.			
X.XX±0.20		单位 UNITS	MM	比例 SCALE	1:1		

乐清市宏一电子有限公司
YueQing HongYi Electronics Co., Ltd

版本 REV.	日期 DATE	ECN NO.	变更内容 DESCRIPTION	制图 DRAWN

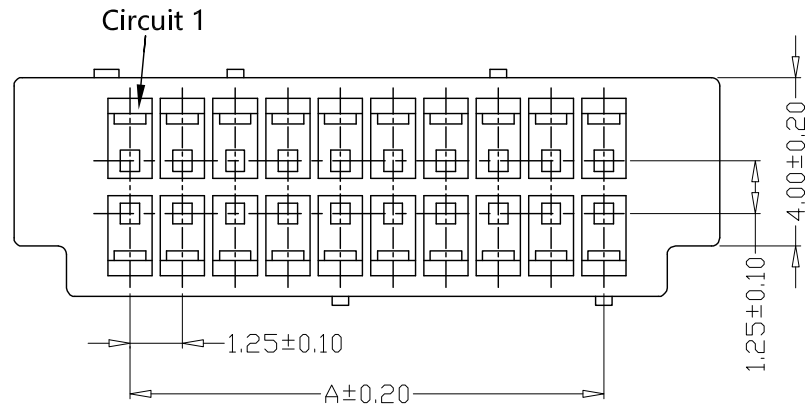

- SPECIFICATIONS
- 1、Current Rating: 1A AC, DC
 - 2、Voltage Rating: 150V AC, DC
 - 3、Temperatuer Range: -25°C~+85°C
 - 4、Contact Resistance: 20mΩ Max
 - 5、Insulation Resistance: 500MΩ Min
 - 6、Withstanding Voltang: 500V AC/minute
 - 7、Material: PA66, UL94V-0

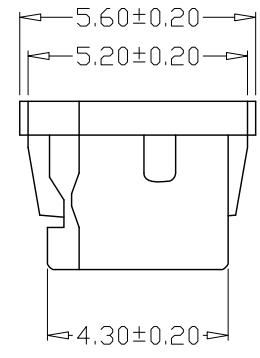
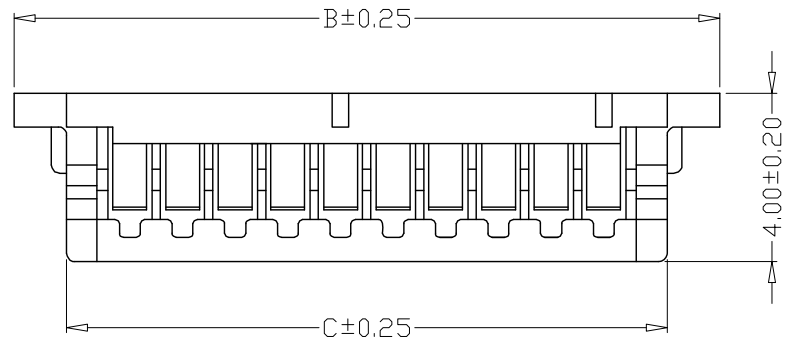

PIN	尺寸 (mm)		
	A	B	C
-2*05Y	5.00	10.50	7.90
-2*10Y	11.25	16.75	14.15
-2*15Y	17.50	23.00	20.40
-2*20Y	23.75	29.25	25.40
-2*25Y	30.00	35.50	31.65

GENERAL TOLERANCE		制图	张迎春	料号	A12506-2*nY	版本	A
X.X±0.25	X.*±2'	DRAWING	2022、08、29	PART NO.		REV.	
X.XXX±0.10		审核	钱岳生	品名	DF13(双排)孔座	页次	1/1
X.XX±0.20		CHECK	2022、08、29	TITLE		SHEET	
		核准	张名	客户料号			
		APPROVAL	2022、08、30	CUTM. NO.			
		单位	MM	比例	1:1		
		UNITS		SCALE		YueQing HongYi Electronics Co., Ltd	

版本 REV.	日期 DATE	ECN NO.	变更内容 DESCRIPTION	制图 DRAWN

SPECIFICATIONS

- 1、Current Rating: 1A AC, DC
- 2、Voltage Rating: 150V AC, DC
- 3、Temperatuer Range: -25°C ~ +85°C
- 4、Contact Resistance: 20mΩ Max
- 5、Insulation Resistance: 500MΩ Min
- 6、Withstanding Voltang: 500V AC/minute
- 7、Material: Wafer LCP, UL94V-0
PIN Phosphoric bronze Gold-plated
Solder tad Phosphoric bronze Tin-plated

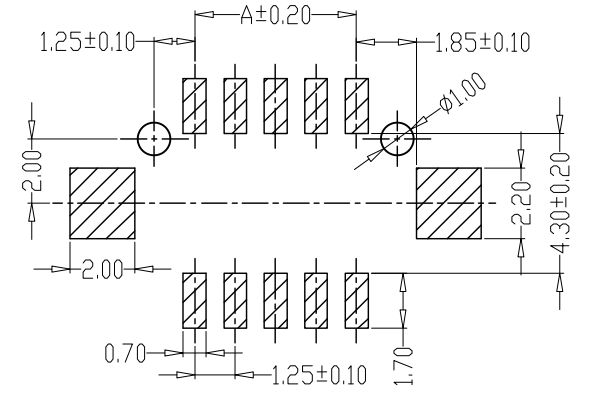
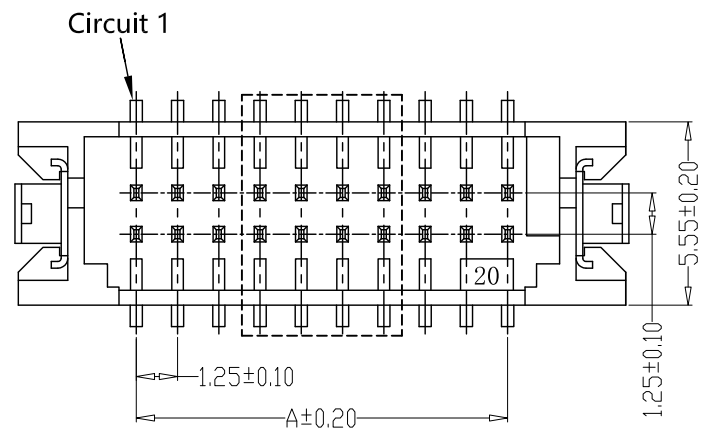

PCB LAYOUT

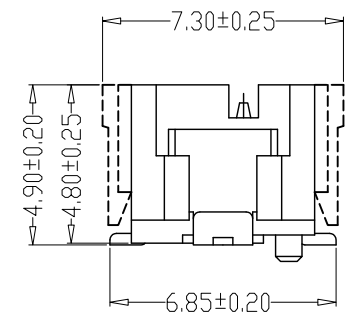
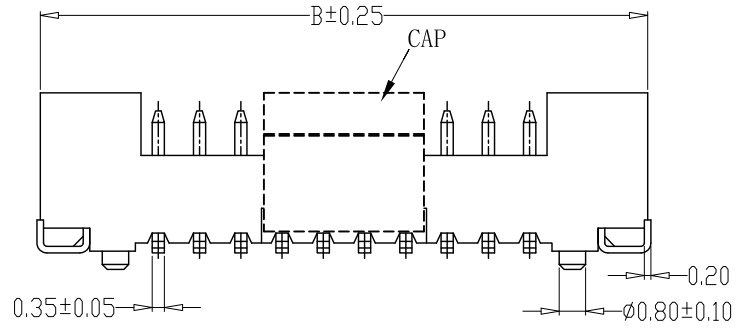

PIN	尺寸 (mm)	
	A	B
-2*05AB	5.00	12.15
-2*10AB	11.25	18.40
-2*15AB	17.50	24.65
-2*20AB	23.75	30.90
-2*25AB	30.00	37.15

GENERAL TOLERANCE		制图	张迎春	料号	A12506-2*nAB	版本	
X.X±0.25	X.*±2'	DRAWING	2022、08、29	PART NO.		REV.	A
X.XXX±0.10		审核	钱岳生	品名	DF13 (双排) 立贴	页次	1/1
X.XX±0.20		CHECK	2022、08、29	TITLE	WAFER SMT TYPE	SHEET	
		核准	张名	客户料号			
		APPROVAL	2022、08、30	CUTM. NO.			
		单位	MM	比例	1:1		
		UNITS		SCALE			

乐清市宏一电子有限公司
YueQing HongYi Electronics Co., Ltd